

# FDP51N25 / FDPF51N25

## N-Channel UniFET™ MOSFET

250 V, 51 A, 60 mΩ

### Features

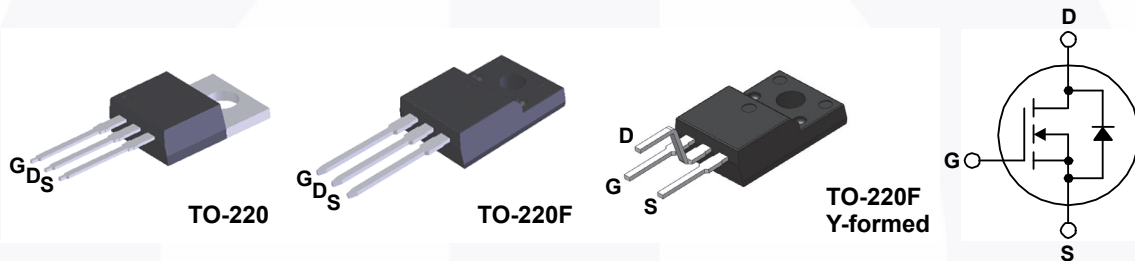
- $R_{DS(on)} = 48 \text{ m}\Omega$  (Typ.) @  $V_{GS} = 10 \text{ V}$ ,  $I_D = 25.5 \text{ A}$
- Low Gate Charge (Typ. 55 nC)
- Low  $C_{rss}$  (Typ. 63 pF)

### Applications

- PDP TV
- Lighting
- Uninterruptible Power Supply
- AC-DC Power Supply

### Description

UniFET™ MOSFET is Fairchild Semiconductor's high voltage MOSFET family based on planar stripe and DMOS technology. This MOSFET is tailored to reduce on-state resistance, and to provide better switching performance and higher avalanche energy strength. This device family is suitable for switching power converter applications such as power factor correction (PFC), flat panel display (FPD) TV power, ATX and electronic lamp ballasts.



### Absolute Maximum Ratings $T_C = 25^\circ\text{C}$ unless otherwise noted.

Symbol	Parameter		FDP51N25	FDPF51N25 / FDPF51N25YDTU	Unit
$V_{DSS}$	Drain-Source Voltage		250		V
$I_D$	Drain Current	- Continuous ( $T_C = 25^\circ\text{C}$ )	51	51*	A
		- Continuous ( $T_C = 100^\circ\text{C}$ )	30	30*	A
$I_{DM}$	Drain Current	- Pulsed (Note 1)	204	204*	A
$V_{GSS}$	Gate-Source voltage		$\pm 30$		V
$E_{AS}$	Single Pulsed Avalanche Energy (Note 2)		1111		mJ
$I_{AR}$	Avalanche Current (Note 1)		51		A
$E_{AR}$	Repetitive Avalanche Energy (Note 1)		32		mJ
$dv/dt$	Peak Diode Recovery $dv/dt$ (Note 3)		4.5		V/ns
$P_D$	Power Dissipation	( $T_C = 25^\circ\text{C}$ )	320	38	W
		- Derate Above $25^\circ\text{C}$	3.7	0.3	W/ $^\circ\text{C}$
$T_J, T_{STG}$	Operating and Storage Temperature Range		-55 to +150		$^\circ\text{C}$
$T_L$	Maximum Lead Temperature for Soldering, 1/8" from Case for 5 Seconds		300		$^\circ\text{C}$

\*Drain current limited by maximum junction temperature.

### Thermal Characteristics

Symbol	Parameter	FDP51N25	FDPF51N25 / FDPF51N25YDTU	Unit
$R_{\theta JC}$	Thermal Resistance, Junction-to-Case, Max.	0.39	3.3	$^\circ\text{C}/\text{W}$
$R_{\theta JA}$	Thermal Resistance, Junction-to-Ambient, Max.	62.5	62.5	$^\circ\text{C}/\text{W}$

## Package Marking and Ordering Information

Part Number	Top Mark	Package	Packing Method	Reel Size	Tape Width	Quantity
FDP51N25	FDP51N25	TO-220	Tube	N/A	N/A	50 units
FDPF51N25	FDPF51N25	TO-220F	Tube	N/A	N/A	50 units
FDPF51N25YDTU	FDPF51N25	TO-220F (Y-formed)	Tube	N/A	N/A	50 units

## Electrical Characteristics $T_C = 25^\circ\text{C}$ unless otherwise noted.

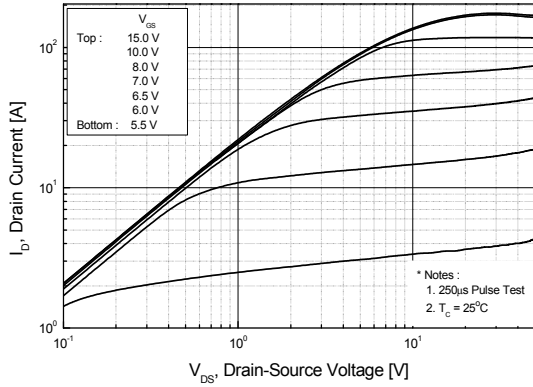
Symbol	Parameter	Conditions	Min.	Typ.	Max.	Unit	
<b>Off Characteristics</b>							
$BV_{DSS}$	Drain-Source Breakdown Voltage	$V_{GS} = 0\text{ V}, I_D = 250\ \mu\text{A}, T_J = 25^\circ\text{C}$	250	--	--	V	
$\Delta BV_{DSS} / \Delta T_J$	Breakdown Voltage Temperature Coefficient	$I_D = 250\ \mu\text{A}$ , Referenced to $25^\circ\text{C}$	--	0.25	--	$\text{V}/^\circ\text{C}$	
$I_{DSS}$	Zero Gate Voltage Drain Current	$V_{DS} = 250\text{ V}, V_{GS} = 0\text{ V}$ $V_{DS} = 200\text{ V}, T_C = 125^\circ\text{C}$	--	--	1 10	$\mu\text{A}$ $\mu\text{A}$	
$I_{GSSF}$	Gate-Body Leakage Current, Forward	$V_{GS} = 30\text{ V}, V_{DS} = 0\text{ V}$	--	--	100	nA	
$I_{GSSR}$	Gate-Body Leakage Current, Reverse	$V_{GS} = -30\text{ V}, V_{DS} = 0\text{ V}$	--	--	-100	nA	
<b>On Characteristics</b>							
$V_{GS(th)}$	Gate Threshold Voltage	$V_{DS} = V_{GS}, I_D = 250\ \mu\text{A}$	3.0	--	5.0	V	
$R_{DS(on)}$	Static Drain-Source On-Resistance	$V_{GS} = 10\text{ V}, I_D = 25.5\text{ A}$	--	0.048	0.060	$\Omega$	
$g_{FS}$	Forward Transconductance	$V_{DS} = 40\text{ V}, I_D = 25.5\text{ A}$	--	43	--	S	
<b>Dynamic Characteristics</b>							
$C_{iss}$	Input Capacitance	$V_{DS} = 25\text{ V}, V_{GS} = 0\text{ V},$ $f = 1\text{ MHz}$	--	2620	3410	pF	
$C_{oss}$	Output Capacitance		--	530	690	pF	
$C_{rss}$	Reverse Transfer Capacitance		--	63	90	pF	
<b>Switching Characteristics</b>							
$t_{d(on)}$	Turn-On Delay Time	$V_{DD} = 125\text{ V}, I_D = 51\text{ A},$ $V_{GS} = 10\text{ V}, R_G = 25\ \Omega$	--	62	135	ns	
$t_r$	Turn-On Rise Time		--	465	940	ns	
$t_{d(off)}$	Turn-Off Delay Time		--	98	205	ns	
$t_f$	Turn-Off Fall Time		(Note 4)	--	130	270	ns
$Q_g$	Total Gate Charge	$V_{DS} = 200\text{ V}, I_D = 51\text{ A},$ $V_{GS} = 10\text{ V}$	--	55	70	nC	
$Q_{gs}$	Gate-Source Charge		(Note 4)	--	16	--	nC
$Q_{gd}$	Gate-Drain Charge		(Note 4)	--	27	--	nC
<b>Drain-Source Diode Characteristics and Maximum Ratings</b>							
$I_S$	Maximum Continuous Drain-Source Diode Forward Current		--	--	51	A	
$I_{SM}$	Maximum Pulsed Drain-Source Diode Forward Current		--	--	204	A	
$V_{SD}$	Drain-Source Diode Forward Voltage	$V_{GS} = 0\text{ V}, I_S = 51\text{ A}$	--	--	1.4	V	
$t_{rr}$	Reverse Recovery Time	$V_{GS} = 0\text{ V}, I_S = 51\text{ A},$ $di_f/dt = 100\text{ A}/\mu\text{s}$	--	178	--	ns	
$Q_{rr}$	Reverse Recovery Charge		--	4.0	--	$\mu\text{C}$	

### Notes:

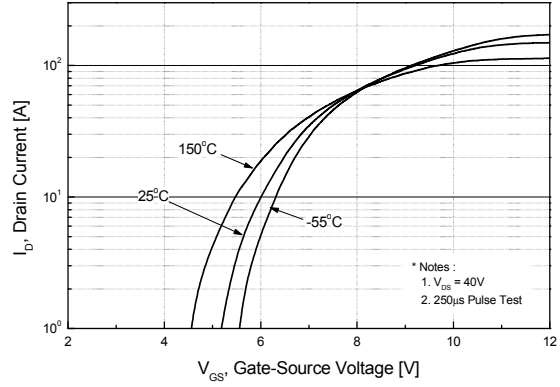
1. Repetitive rating: pulse-width limited by maximum junction temperature.
2.  $L = 0.68\text{ mH}, I_{AS} = 51\text{ A}, V_{DD} = 50\text{ V}, R_G = 25\ \Omega$ , starting  $T_J = 25^\circ\text{C}$ .
3.  $I_{SD} \leq 51\text{ A}, di/dt \leq 200\text{ A}/\mu\text{s}, V_{DD} \leq BV_{DSS}$ , starting  $T_J = 25^\circ\text{C}$ .
4. Essentially independent of operating temperature typical characteristics.

## Typical Performance Characteristics

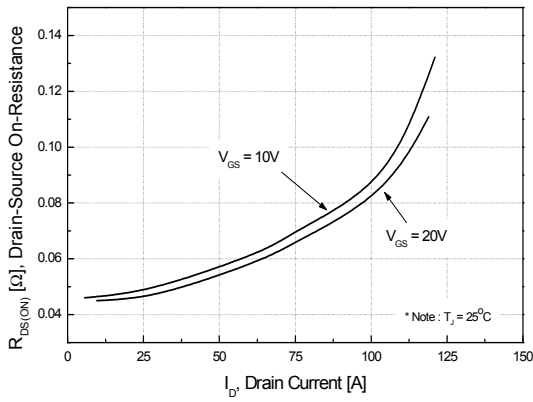
**Figure 1. On-Region Characteristics**



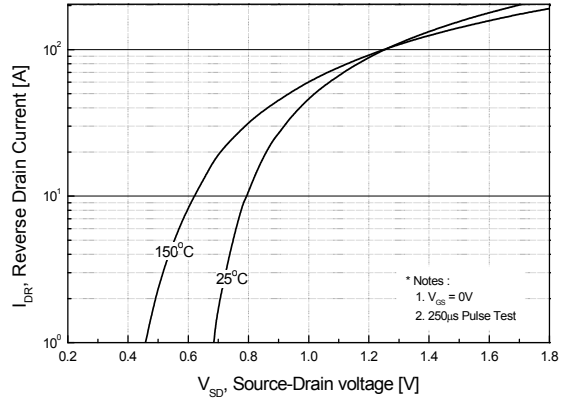
**Figure 2. Transfer Characteristics**



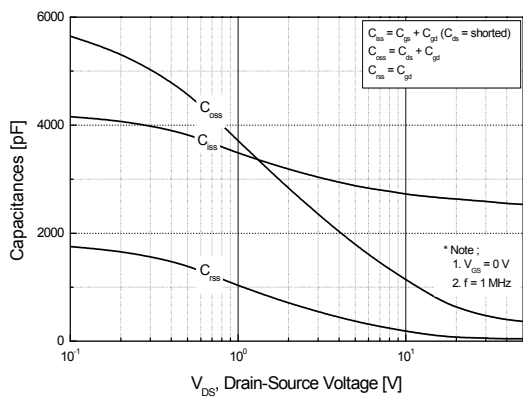
**Figure 3. On-Resistance Variation vs. Drain Current and Gate Voltage**



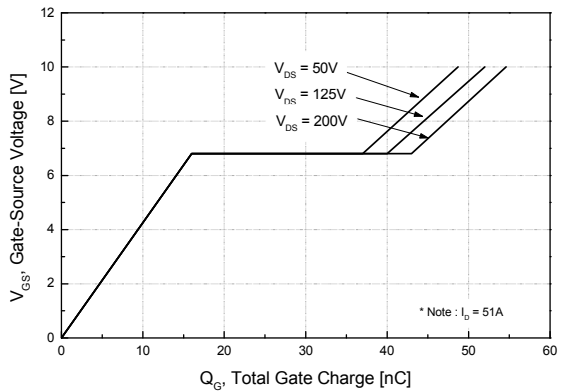
**Figure 4. Body Diode Forward Voltage Variation vs. Source Current and Temperature**



**Figure 5. Capacitance Characteristics**

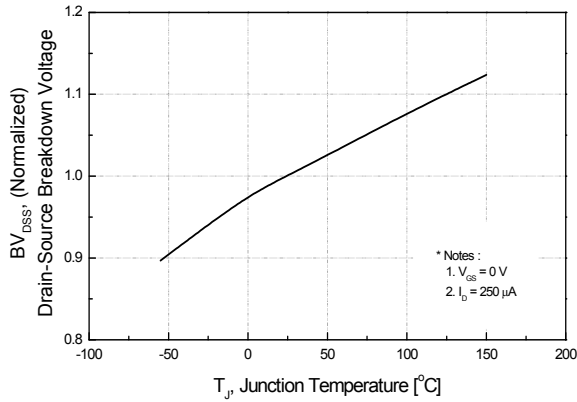


**Figure 6. Gate Charge Characteristics**

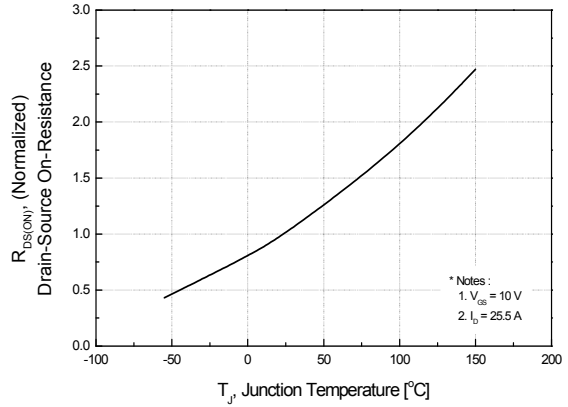


**Typical Performance Characteristics** (Continued)

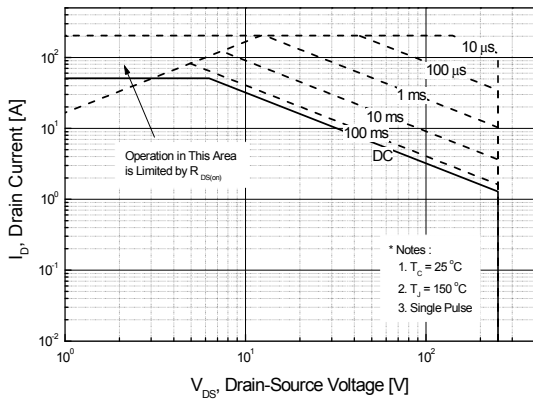
**Figure 7. Breakdown Voltage Variation vs. Temperature**



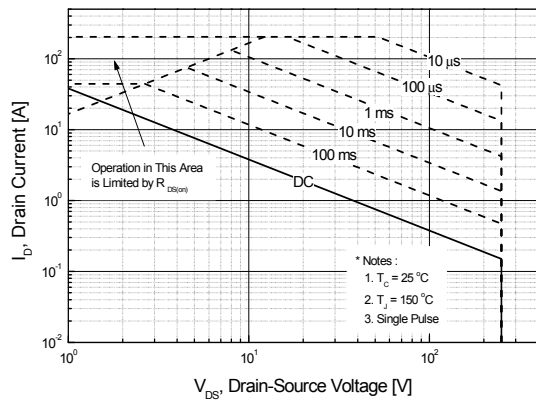
**Figure 8. On-Resistance Variation vs. Temperature**



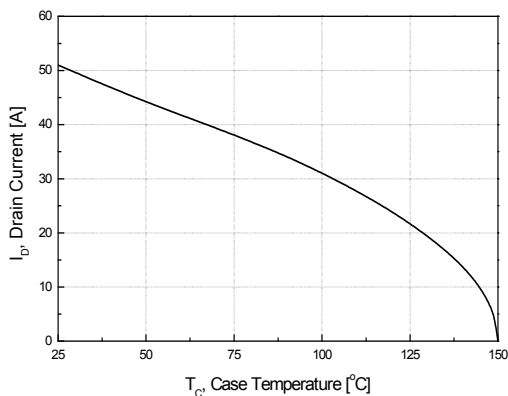
**Figure 9-1. Maximum Safe Operating Area for FDP51N25**



**Figure 9-2. Maximum Safe Operating Area for FDPF51N25 / FDPF51N25YDTU**



**Figure 10. Maximum Drain Current vs. Case Temperature**



Typical Performance Characteristics (Continued)

Figure 11-1. Transient Thermal Response Curve for FDP51N25

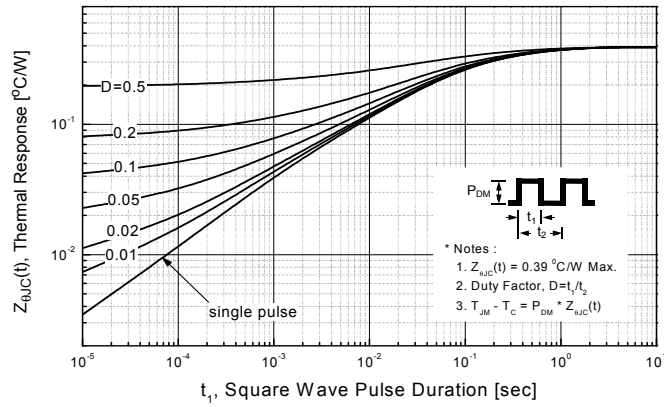


Figure 11-2. Transient Thermal Response Curve for FDPF51N25 / FDPF51N25YDTU

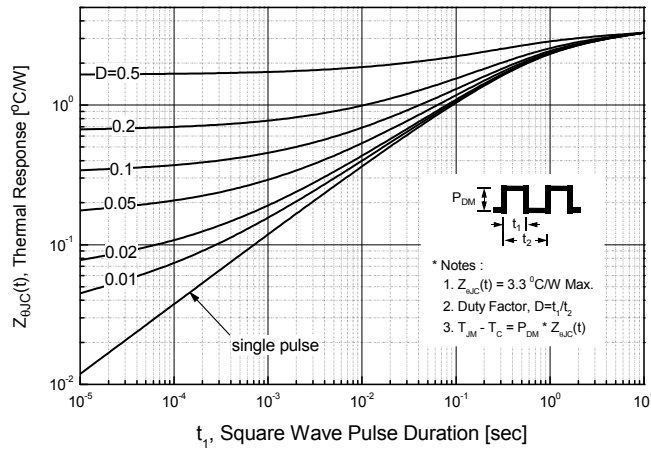




Figure 12. Gate Charge Test Circuit & Waveform



Figure 13. Resistive Switching Test Circuit & Waveforms



Figure 14. Unclamped Inductive Switching Test Circuit & Waveforms



Figure 15. Peak Diode Recovery  $dv/dt$  Test Circuit & Waveforms

## Mechanical Dimensions



**Figure 16. TO-220, Molded, 3-Lead, Jedec Variation AB**

Package drawings are provided as a service to customers considering Fairchild components. Drawings may change in any manner without notice. Please note the revision and/or date on the drawing and contact a Fairchild Semiconductor representative to verify or obtain the most recent revision. Package specifications do not expand the terms of Fairchild's worldwide terms and conditions, specifically the warranty therein, which covers Fairchild products.

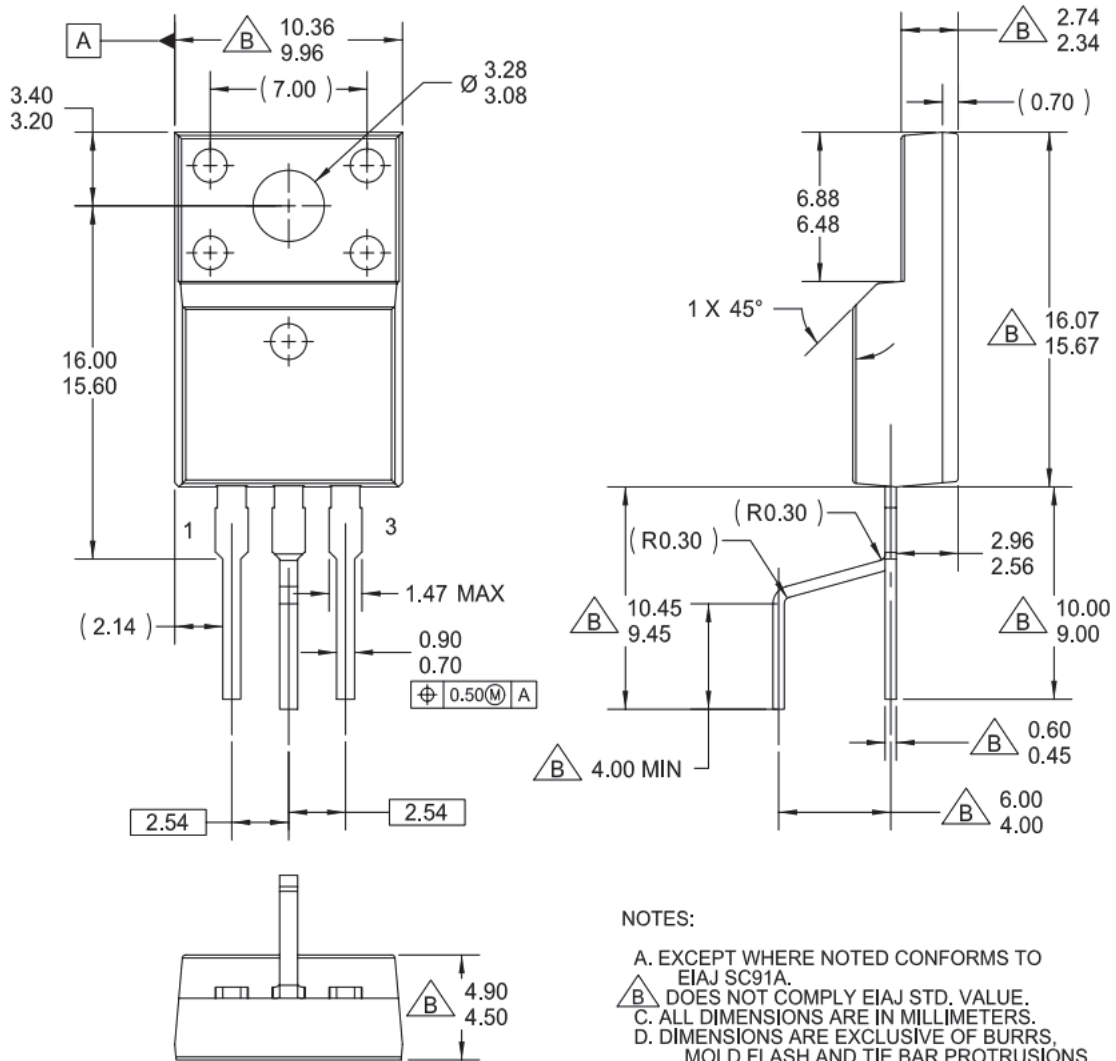
Always visit Fairchild Semiconductor's online packaging area for the most recent package drawings:

[http://www.fairchildsemi.com/package/packageDetails.html?id=PN\\_TT220-003](http://www.fairchildsemi.com/package/packageDetails.html?id=PN_TT220-003)





## Mechanical Dimensions



### NOTES:

- A. EXCEPT WHERE NOTED CONFORMS TO EIAJ SC91A.
- B. DOES NOT COMPLY EIAJ STD. VALUE.
- C. ALL DIMENSIONS ARE IN MILLIMETERS.
- D. DIMENSIONS ARE EXCLUSIVE OF BURRS, MOLD FLASH AND TIE BAR PROTRUSIONS.
- E. DIMENSION AND TOLERANCE AS PER ASME Y14.5-1994.
- F. DRAWING FILE NAME: TO220Q03REV1

**Figure 18. TO220, Molded, 3-Lead, Full Pack, EIAJ SC91, Y-Formed**

Package drawings are provided as a service to customers considering Fairchild components. Drawings may change in any manner without notice. Please note the revision and/or date on the drawing and contact a Fairchild Semiconductor representative to verify or obtain the most recent revision. Package specifications do not expand the terms of Fairchild's worldwide terms and conditions, specifically the warranty therein, which covers Fairchild products.

Always visit Fairchild Semiconductor's online packaging area for the most recent package drawings:

[http://www.fairchildsemi.com/package/packageDetails.html?id=PN\\_TF220-FA3](http://www.fairchildsemi.com/package/packageDetails.html?id=PN_TF220-FA3)

